

Highly Accurate 2-Channel Voltage/Current Source Measure Unit

GS820 Multi Channel SOURCE MEASURE UNIT

- 2-channel source and measurement function
- Source and measurement ranges: 7 V and 3.2 A or 18 V and 1.2 A
- Minute current range of 200-nA at 1-pA resolution
- Generate arbitrary waveforms consisting of up to 100,000 points at 100- μ s intervals
- Fast test speeds
- 16-bit digital I/O (model 765602)



Application Examples

DC voltage/current reference, V-I curve trace, semiconductor parametric test, pulse voltage/current source, programmable arbitrary waveform generation, electronic load, resistance measurement, Production test

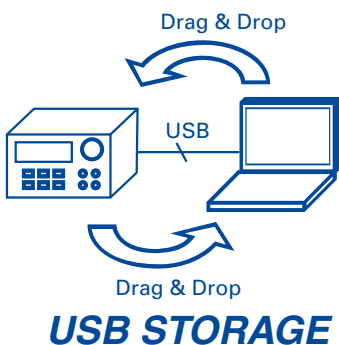

GS820

Highly Accurate 2-Channel Voltage/Current Source Measure Unit
Multi Channel Source Measure Unit

The GS820 is a highly accurate and highly functional 2-channel programmable DC voltage/current source that incorporates voltage/current generation and measurement functions.

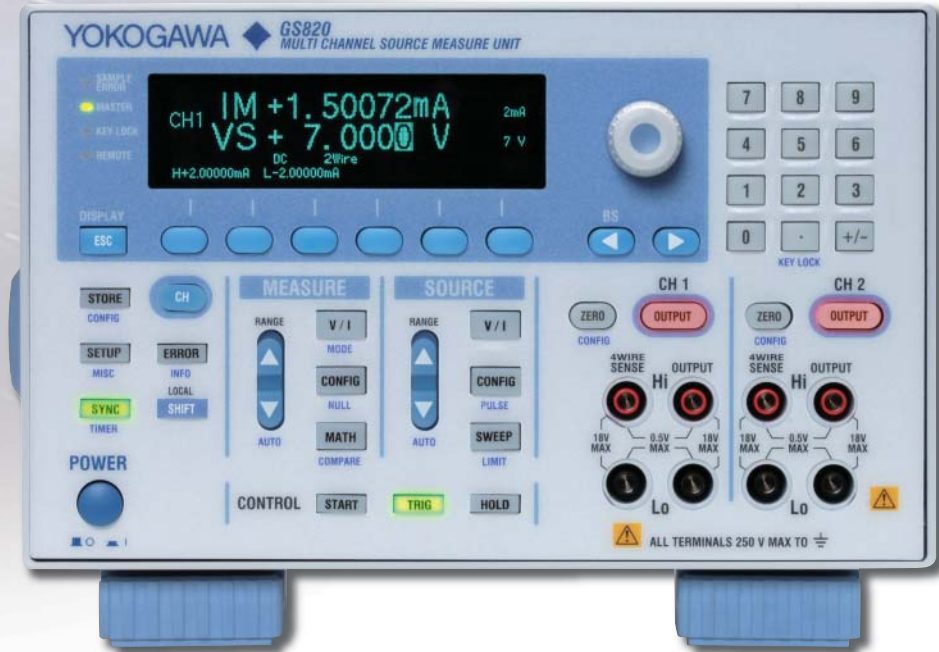

Features

- Isolated 2-channel source and measurement function
- Source and measurement ranges: 7 V and 3.2 A or 18 V and 1.2 A
- Minute current ranges with 200-nA or 1-pA resolution
- Generate arbitrary waveforms consisting of up to 100,000 points at 100- μ s intervals
- Channel expansion through master-slave synchronization link
- Fast test speeds
- 16-bit digital I/O (model 765602)

2-channel display example (256 x 64 dot matrix display)

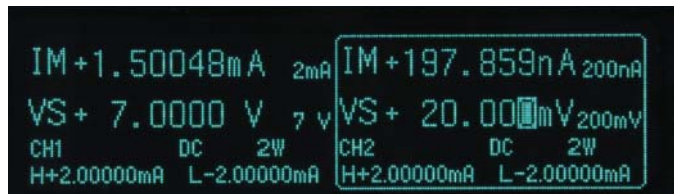

Source and Measurement Range

Four-quadrant operation consisting of source operation (current source) and sink operation (current sink) is available with ranges up to 7 V and 3.2 A or 18 V and 1.2 A. The output and measurement resolutions are 5.5 digits.

- Voltage ranges: 200 mV, 2 V, 7 V, and 18 V
- Maximum output current: ± 3.2 A (at an output voltage of ± 7 V or less)
 ± 1.2 A (at an output voltage of ± 18 V or less)
- Current ranges: 200 nA, 2 μ A, 20 μ A, 200 μ A, 2 mA, 20 mA, 200 mA, 1 A, and 3 A
- Maximum output voltage: ± 18 V (at an output current of ± 1.2 A or less)
 ± 7 V (at an output current of ± 3.2 A or less)

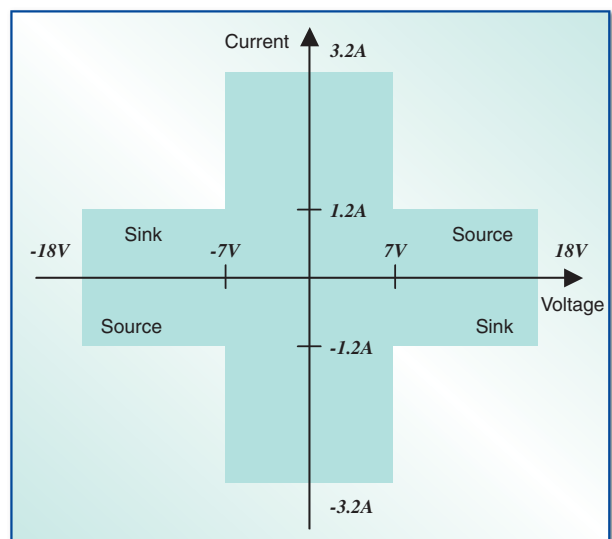

GS820 Construction and Functions

The GS820 is equipped with two analog channels with each channel consisting of a constant voltage source VS, a constant current source IS, a voltmeter VM, and an ammeter IM. The two source measure channels are isolated.

Source and Measurement Functions:

- Voltage source and current measurement (VS&IM)
- Current source and voltage measurement (IS&VM)
- Voltage source (VS)
- Current source (IS)
- Voltmeter (VM)
- Ammeter (IM)
- Resistance meter (IS&VM)

These functions can be selected for each channel to form an arbitrary combination of functions.

Allows voltage sensing of a two-wire system or four-wire system by switching between local sense and remote sense.

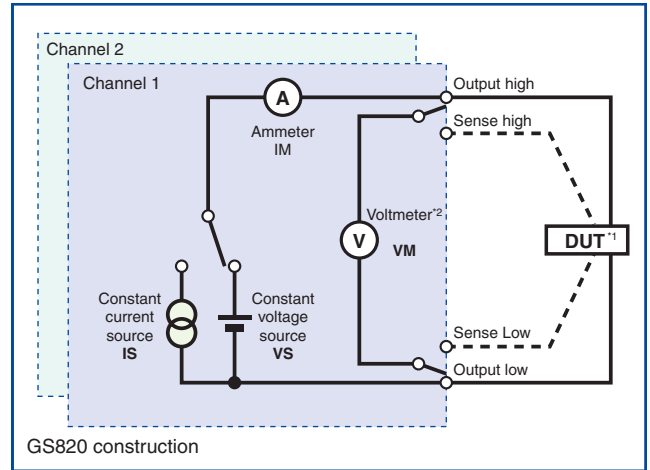

*1: Device under Test
 *2: For DUT voltage measurement
 --- Used to measure a four-wire system

Combination of Source and Measurement Functions

The combination of the source and measurement functions of two channels allows the testing of various DUTs.

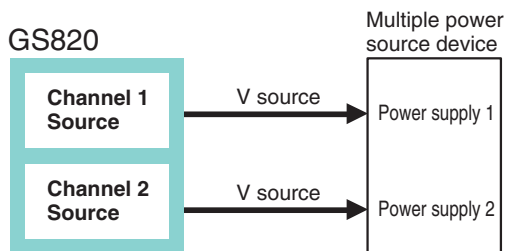

Channel Number	Operation Mode
1	Source
2	Source

Application examples:
 CPU, multi-core MPU, embedded device, hybrid IC, disk drive, and various board assemblies

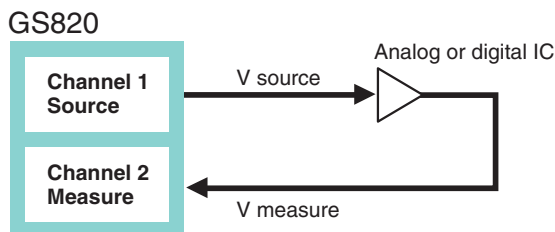

Channel Number	Operation Mode
1	Source
2	Measure

Application examples:
 Op Amp, comparator, logic IC, and various board assemblies

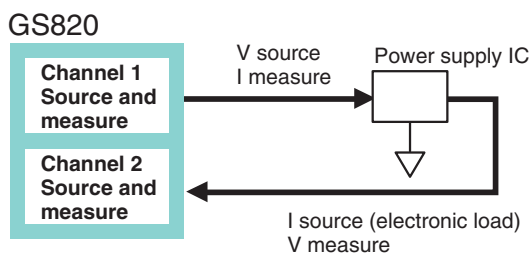

Channel Number	Operation Mode
1	Source and measure
2	Source and measure

Application examples:
 Three-terminal regulator, DC-DC converter, bipolar transistor, FET, and various board assemblies

Source and Measurement Timing

Basic Source Measurement Timing

The GS820 performs generation and measurement using its internal timer or a trigger input such as an external input signal. When a trigger signal is received, the GS820 starts generating a signal after the source delay time elapses and carries out a measurement after the measure delay time elapses over a given integration time. The measurement integration time can be set in the range of 0.001 PLC to 25 PLC.² Additionally, the GS820 provides an auto zero measurement function, which measures the internal zero reference after the measurement and performs offset correction in real-time. The integration time of the auto zero measurement is equal to the measurement integration time setting.

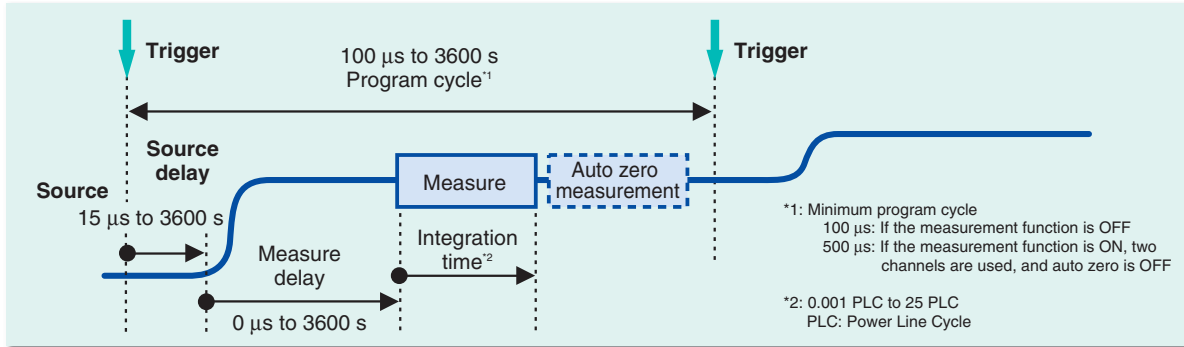

Timing Settings Using Various Trigger Sources

The GS820 allows the generation trigger source and measurement trigger source to be set separately. There are two types of constant period timers and an external signal input that can be used for the generation trigger source. In addition to these sources, source change point and sweep end point can be used for the measurement trigger source. Because the source trigger and measurement trigger can be set separately and also separately for each channel, source and measurement under various connection conditions and timing combinations can be accommodated. There is also an auxiliary trigger that can be activated using an external signal or a program event. The source delay, measure delay, and integration time can be set separately for each channel.

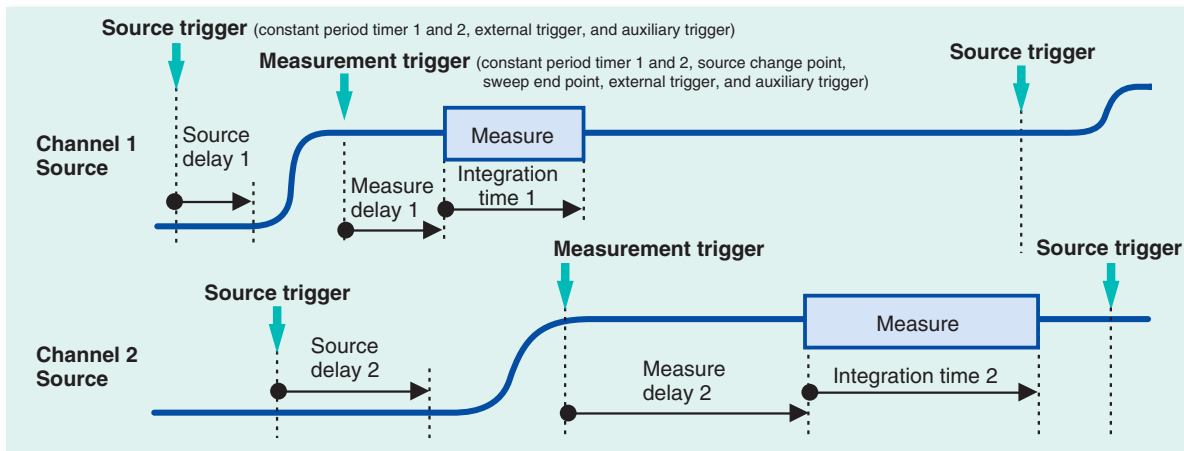

Asynchronous Operation of Source and Measure

The various trigger sources available on the GS820 allow the source and measurement to be executed asynchronously. The figure below shows an example in which separate timers are used for the source and measurement to achieve multiple measurements in a source cycle.

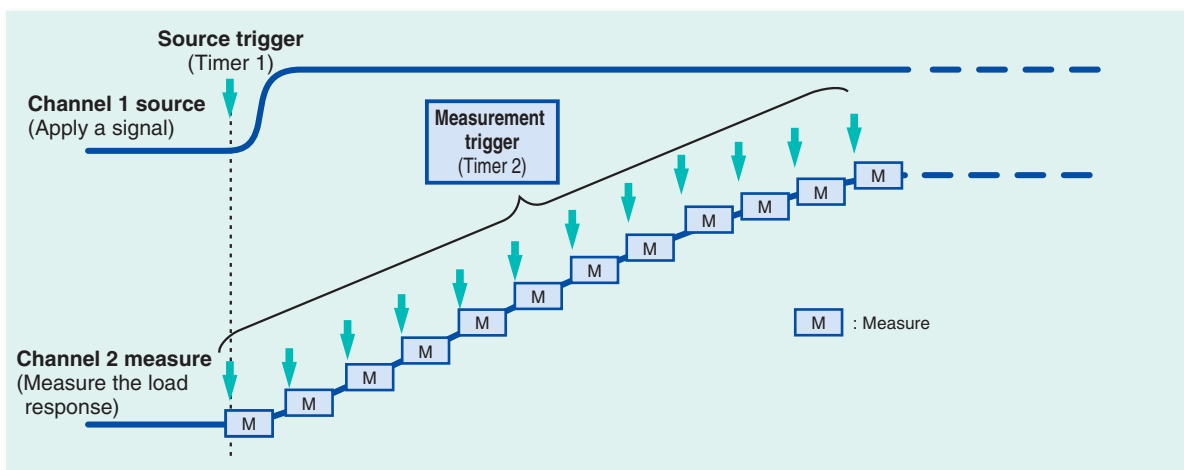

Sweep Function 1: Preset Sweep

The voltage/current generation block of the GS820 operates in DC generation mode or pulse generation mode. Each generation mode has preset operation modes such as continuous output, linear sweep, and log sweep that allow the user to perform sweep operations by setting simple parameters. The output level can be changed at a minimum of 100- μ s intervals¹ in each sweep mode.

¹: See *1 minimum program cycle on page 4.

Source Mode	No Sweep	Linear Sweep	Log Sweep
DC source			
Pulse source			

Sweep Function 2: Arbitrary Waveform Generation of Up to 100,000 Points and Simultaneous Sweeping of Control Parameters

In addition to the preset sweep functions described above, the GS820 is equipped with a programmable sweep function that allows the user to define the sweep pattern. A user can create or edit arbitrary waveform data (CSV format) of up to 100,000 points using a spreadsheet or text editor. The GS820 is also capable of sweeping the timing and control parameters in addition to the source level. This allows a control sequence that is synchronized to the waveform generation timing. The sweep program can be changed at a minimum of 100- μ s intervals¹ in programmable sweep mode.

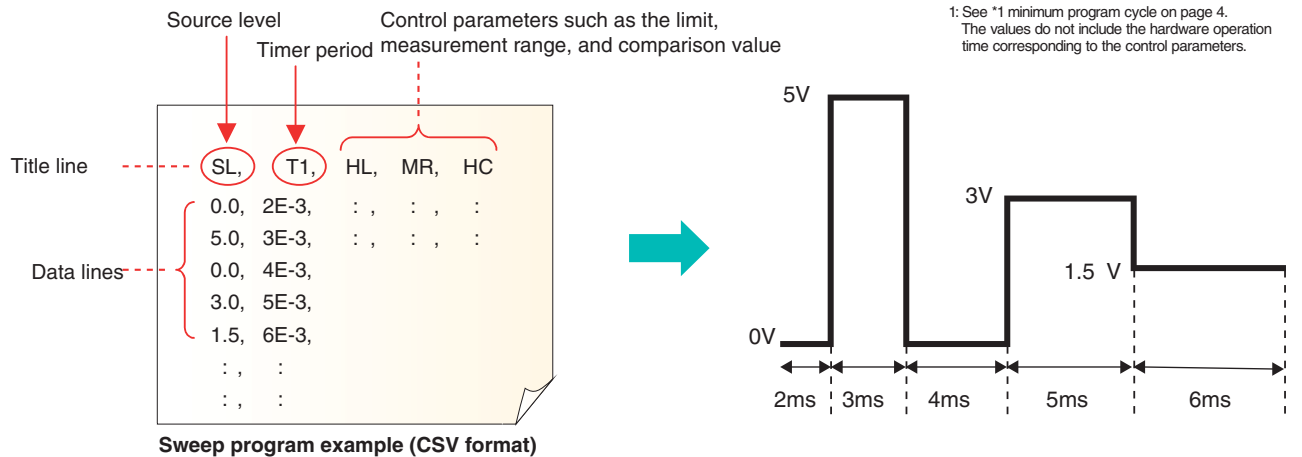

Control parameters that can be included in a sweep program

Title Symbol	Parameter	Title Symbol	Parameter
[CHn.] SF	Source function	T1	Timer 1 period
↓ SR	Source range	T2	Timer 2 period
↓ SL	Source level	AT	Auxiliary trigger generation
↓ HL	High limit	DO	Digital output
↓ LL	Low limit		
↓ SD	Source delay		
↓ PW	Pulse width		
↓ PB	Pulse base		
↓ MS	Measure ON/OFF		
↓ MF	Measure function		
↓ MR	Measure range		
↓ MD	Measure delay		
↓ HC	Compare high		
↓ LC	Compare low		

- Write the items you want to define in the title line.
- The items that you can include are source value, measure value, limit value, measurement range, comparison value, period, delay, etc.
- A channel can be specified for each item (excluding timer, trigger, and digital output).

* [CHn.]: Specify the channel by setting n = 1 or 2

Test Sequence Editing (Application to Auto Testing Equipment)

The GS820 allows the editing of test sequences suitable for auto testing on the production lines. A user can write program file parameters that are vital to auto testing such as the source value, measured value, high limit for comparison, low limit for comparison, comparison result, control bit output, etc. Because the program file is in CSV format, a popular spreadsheet application can be used to edit and view the program.

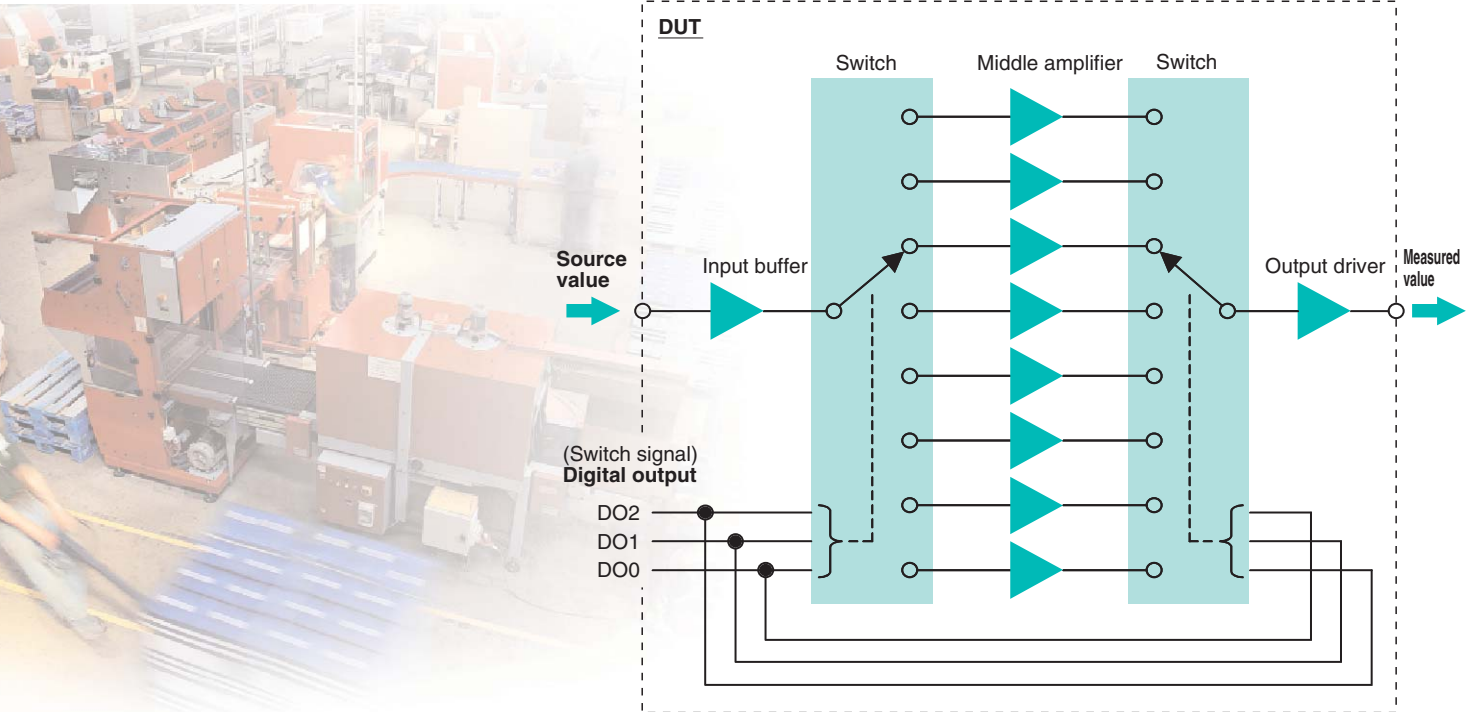

Time stamp	Digital output	Digital input	Source function	Source value	Measurement function	Measured value	Low limit for comparison	High limit for comparison	Comparison result
TM	DO	DI	CH1:SF	CH1:SL	CH1:MF	CH1:ML	CH1:LC	CH1:HC	CH1:CP
0.0000	0x0000	0x0000	V	+1.00000E+0	V	+2.00122E+0	+1.95000E+0	+2.05000E+0	P
0.2000	0x0000	0x0000	V	+2.00000E+0	V	+4.00255E+0	+3.90000E+0	+4.10000E+0	P
0.4000	0x0001	0x0000	V	+1.00000E+0	V	+2.01156E+0	+1.95000E+0	+2.05000E+0	P
0.6000	0x0001	0x0000	V	+2.00000E+0	V	+4.02302E+0	+3.90000E+0	+4.10000E+0	P
:	:	:	:	:	:	:	:	:	:

Example of a measurement result file

Test Speed (Improvement in the Takt Time in the Production Line Test)

The GS820 provides fast operation for production line tests. The measured results of test speeds (reference data) are indicated below.

Measured values of test speeds (reference data)^{*1}

Task	Operation Time	Command Used	Conditions
Change the source level (1 channel)	423 μs	:chan1:sour:lev +15.0000	Measurement function OFF, source range fixed to 18 V.
Change the source level (2 channels)	910 μs	:chan1:sour:lev +15.0000; :chan2:sour:lev -0.12500	Same as above
Change the range and source level	978 μs	:chan1:sour:rang 18V; lev +15.0000	Measurement function OFF
Change the limiter and source level	1,048 μs	:chan1:sour:lev +15.0000; prot:lev 200uA	Measurement function OFF, source range fixed to 18 V.
Switch the source function	457 μs	:chan1:sour:func volt	-
Measure (1 channel)	613 μs	:chan1:meas?	Integration time 0.001 PLC, auto zero OFF, and external trigger OFF.
Measure (2 channels simultaneously)	820 μs	:meas? dual	Same as above
Change the source level and measure (1 channel)	985 μs	:chan1:sour:lev +15.0000; :chan1:meas?	Same as above, source range fixed to 18 V.
Change the source level and measure (2 channels)	1,686 μs	:chan1:sour:lev +15.0000; :chan2:sour:lev -0.12500;meas? dual;	Same as above

*1: Measurement environment
Core 2 Duo processor 2.33 GHz, USB2.0, using LabView

Channel Expansion (Expansion up to 10 Channels Using the Master-Slave Operation)

Multiple GS820s can be connected as shown below and used as a multi-channel source measure unit. The master-slave feature allows the program data of all connected channels to be set and collected by simply accessing the master unit. The master unit ① distributes the source data to the slave units or ② collects and merges the measured data of all slave units. Complete synchronization of all channels can be achieved by connecting the exclusive trigger signal line.

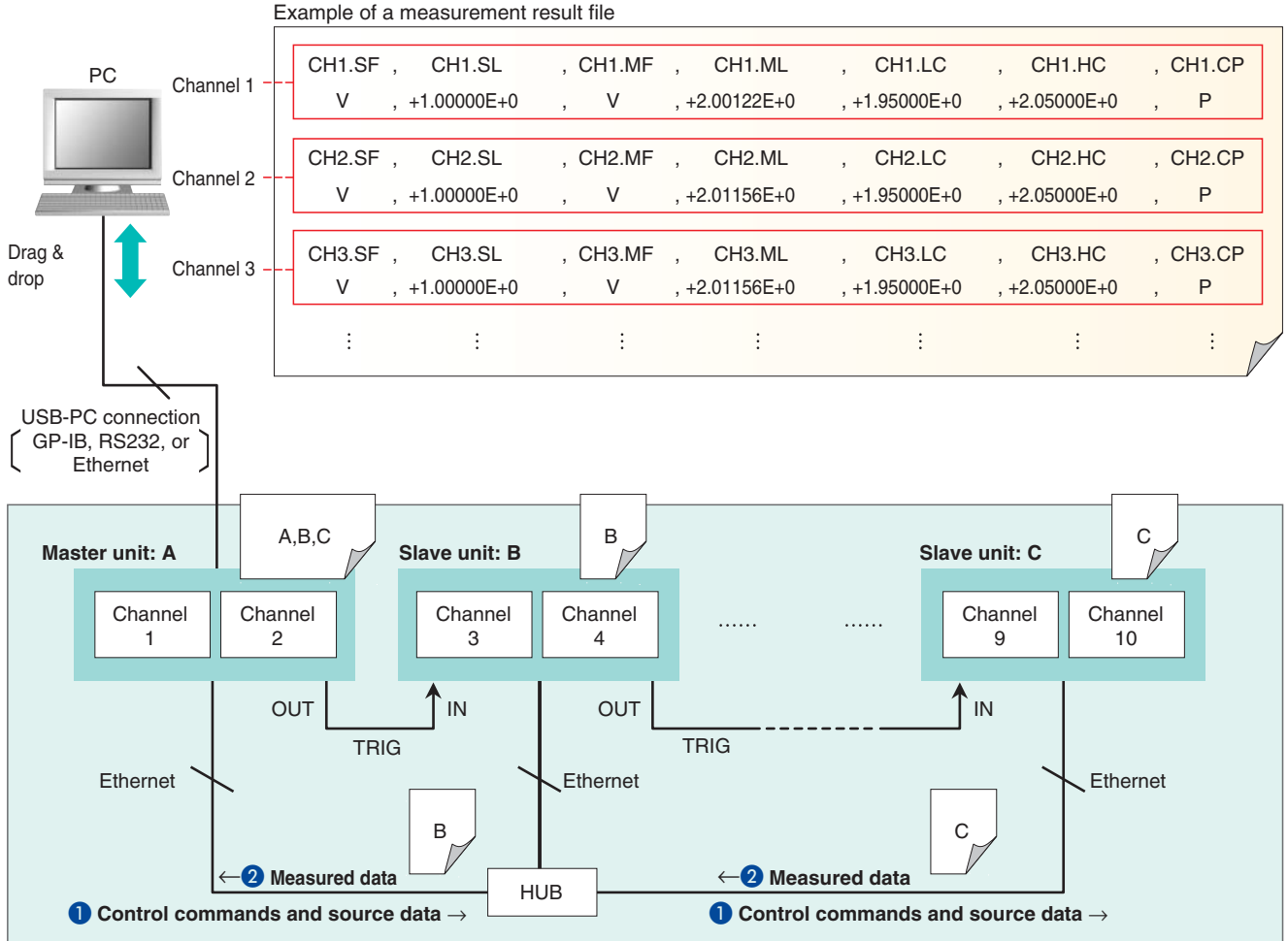

Zero Generation Function of Voltage and Current (Fast Load Disconnection without Chattering)

The zero generation function of the GS820 generates zero voltage or current as well as controls the current/voltage limiter to limit the load current. The GS820 stops applying the voltage or supplying the current to the load in the zero generation state allowing the DUT to be disconnected with the output relay turned ON. This function avoids the problems of chattering and contact life of the output relay and reduces the time for turning ON/OFF the output.

Zero generation of voltage

- Low impedance: The current limiter is set to the specified value.
- High impedance: The current limiter is set to 10 nA.

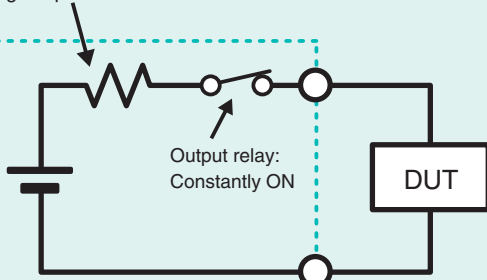

Zero generation of current

- Low impedance: The voltage limiter is set to 1 mV.
- High impedance: The voltage limiter is set to the specified value.

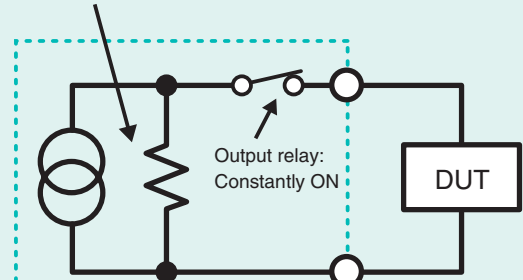

Measurement of the Static Characteristics of Three-Terminal Semiconductor Devices (Transistors, FETs, etc.)

The GS820 can measure drain current I_D by applying gate-source voltage V_{GS} from channel 1 and drain-source voltage V_{DS} from channel 2.

Connection example for measurements

Features

- Voltage application and current measurement using two synchronized channels
- Minute current measurement at 200-nA range and 1-pA resolution
- Curve trace function using voltage/current sweep
- Output measured data in CSV format
- Easy access to the internal USB memory
- No dedicated software required

Measurement data file

CH1.Vgs(V)	CH2.Id(A)
0.00E+00	8.87E-03
-2.00E-02	8.46E-03
-4.00E-02	8.05E-03
-6.00E-02	7.65E-03
-8.00E-02	7.26E-03
-1.00E-01	6.87E-03
-1.20E-01	6.49E-03
-1.40E-01	6.12E-03
-1.60E-01	5.76E-03

(data edited in the spreadsheet)

Graph

Timing Tests at Power-On of Multiple Power Supplies

The GS820 can generate different supply voltages from the two channels to drive a multiple power source device. The transient changes in the source voltage can be programmed by entering values in a general-purpose spreadsheet.

Timing at Power-On (Source Data)

Features

- Synchronized output of two power supplies
- Maximum output current of 3.2 A x 2 channels
- Easy voltage programming
- No dedicated software required

Source data file

1.4-V power supply (V)	3.3-V power supply (V)
0.00	0.00
0.01	0.02
0.02	0.04
0.03	0.06
0.04	0.08
0.05	0.10
0.06	0.12
0.07	0.14
0.08	0.16
0.09	0.18
0.10	0.20
0.11	0.22
0.12	0.24

Startup waveform of multiple power supplies

DL9000 Series Digital Oscilloscope

Microprocessor

GS820 Source Measure Unit

Measurement of I/O Characteristics of Semiconductor Devices

The GS820 is used to apply voltage V_i to the gate input of a logic IC from channel 1 and measure gate output voltage V_o on channel 2. The source and measure channels allow the I/O characteristics of the gate to be measured.

GS820 Source Measure Unit

Channel 1 V source

Channel 2 V measurement

Measurement data file

CH1.Vi (V)	CH2.Vo (V)
0.00E+00	5.01E+00
2.00E-01	5.01E+00
4.00E-01	5.01E+00
6.00E-01	5.01E+00
8.00E-01	5.01E+00
1.00E+00	5.01E+00
1.20E+00	5.01E+00
1.40E+00	5.01E+00
1.60E+00	5.01E+00
1.80E+00	5.01E+00

(data edited in the spreadsheet)

Features

- Voltage application and voltage measurement using two synchronized channels
- Curve trace function using voltage sweep
- Output measured data in CSV format
- Easy access to the internal USB memory
- No dedicated software required

I/O characteristics of a NAND gate

Output voltage V_o (V)

Input voltage V_i (V)

Power Conversion Efficiency Measurement of Power Supply ICs

The GS820 can measure the power conversion efficiency of a three-terminal regulator or a DC-DC converter. A channel for supplying power is connected to the primary circuit and another channel for consuming power is connected to the secondary circuit. Then, the load current is swept to vary the consumed power and supplied power. The power conversion efficiency is determined from the ratio of the consumed power to the supplied power.

GS820 Source Measure Unit

Channel 1 I measurement

Channel 2 V measurement

Measurement result example (data edited in the spreadsheet)

Time(s)	Voltage and current in the primary circuit		Voltage and current in the secondary circuit		Efficiency = Consumed power in the secondary circuit / supplied power in the primary circuit		
	Source(V)	Measure(A)	Source(A)	Measure(V)	Input(W)	Output(W)	Efficiency
0	7.00	0.002617	0.00	4.95495	1.83E-02	0.00E+00	0.00%
0.5	7.00	0.102457	-0.10	4.94771	7.17E-01	4.95E-01	68.99%
1.1	7.00	0.202470	-0.20	4.94113	1.42E+00	9.88E-01	69.73%
1.65	7.00	0.302443	-0.30	4.93466	2.12E+00	1.48E+00	69.93%
2.2	7.00	0.402436	-0.40	4.92822	2.82E+00	1.97E+00	69.98%
2.75	7.00	0.502437	-0.50	4.92177	3.52E+00	2.46E+00	69.97%
3.3	7.00	0.602380	-0.60	4.91529	4.22E+00	2.9	69.94%
3.85	7.00	0.702407	-0.70	4.90882	4.92E+00	3.4	69.89%
4.4	7.00	0.802434	-0.80	4.90221	5.62E+00	3.9	69.82%
4.95	7.00	0.902451	-0.90	4.89524	6.32E+00	4.4	69.74%

Power conversion efficiency of a voltage regulator

Output voltage (V)

Power conversion efficiency

Output current (A)

Legend: Output Voltage, Efficiency

* More application examples are introduced at our Website.
 URL: http://www.yokogawa.com/tm/gmi/gs610/tm-gs610_10.htm

Source Section

DC Voltage Source

Range	Source Range	Resolution	Max. Load Current	Accuracy (One Year) ±(% of setting + V)	Temperature Coefficient ±(% of setting + V)/°C
200 mV	±200.000 mV	1 µV	±3.2 A	0.02 + 250 µV	0.003 + 35µV
2 V	±2.00000 V	10 µV	±3.2 A	0.02 + 400 µV	0.003 + 60µV
7 V	± 7.0000 V	100 µV	±3.2 A	0.02 + 2 mV	0.003 + 300µV
18 V	±18.0000 V	100 µV	±1.2 A	0.02 + 2 mV	0.003 + 300µV

Output resistance (for four-wire system remote sensing)
 200 mV, 2 V range: (Shunt resistance/40000) Ω or less
 7 V, 18 V range: (Shunt resistance/5000) Ω or less
 * Shunt resistance: See "DC Current Measurement"

One year accuracy for 23±5 °C.
 Add the temperature coefficient for 5 to 18 °C and 28 to 40°C.

DC Current Source

Range	Source Range	Resolution	Max. Load Voltage	Accuracy (One Year) ±(% of setting + A)	Temperature Coefficient ±(% of setting + A)/°C
200nA	±200.000nA	1pA	±18V	0.06 + 3nA	500pA
2µA	±2.00000µA	10pA	±18V	0.04 + 3nA	500pA
20µA	±20.0000µA	100pA	±18V	0.03 + 3nA	0.0045 + 450pA
200µA	±200.000µA	1nA	±18V	0.03 + 30nA	0.0045 + 4.5nA
2mA	±2.00000 mA	10nA	±18 V	0.03 + 250 nA	0.0045 + 37.5 nA
20mA	±20.0000 mA	100nA	±18 V	0.03 + 2.5µA	0.0045 + 375 nA
200mA	±200.000 mA	1µA	±18 V	0.03 + 25µA	0.0045 + 3.75 µA
1A	±1.20000 A	10µA	±18 V	0.05 + 900µA	0.0075 + 135 µA
3A	±3.20000 A	10 µA	±7 V	0.05 + 1.5 mA	0.0075 + 225 µA

One year accuracy for 23±5 °C.
 Add the temperature coefficient for 5 to 18 °C and 28 to 40 °C.

Output resistance
 (Shunt resistance x 50000) Ω or more
 * Shunt resistance: See "DC Current Measurement"

One year accuracy for 23±5 °C.
 Add the temperature coefficient for 5 to 18 °C and 28 to 40 °C.

Current Limiter

Setting ^{*1}	Range	Resolution	Min. Setting
10.000 nA to 200.000 nA	200nA	1pA	10nA
0.20001 µA to 2.00000 µA	2µA	10pA	10nA
2.00001 µA to 20.0000 µA	20 µA	100pA	100nA
20.0001 µA to 200.000 µA	200 µA	1nA	1µA
200.001 µA to 2.00000 mA	2 mA	10nA	10µA
2.00001 mA to 20.0000 mA	20 mA	100nA	100µA
20.0001 mA to 200.000 mA	200 mA	1µA	1mA
0.20001 A to 1.20000 A	1A	10µA	10mA
1.20001 A to 3.20000 A	3A	10µA	10mA

Voltage Limiter

Setting ^{*1}	Range	Resolution	Min. Setting
1.000 mV to 200.000 mV	200 mV	1 µV	1 mV
0.20001 V to 2.00000 V	2 V	10 µV	1 mV
2.00001 V to 7.0000 V	7 V	100 µV	5 mV
7.0001 V to 18.0000 V	18 V	100 µV	5 mV

*1: Larger of the two values (high limit value) or (low limit value) when tracking is OFF

Response Time (Typical)

Source	Range	Response Time
Current Source	200 mV range	250µs
	2 V range	50µs
	7 V, 18 V range	100µs
	200 nA range	250ms
Voltage Source	2 µA range	25ms
	20 µA range	2.5ms
	200 µA range	250µs
	2 mA to 3 A range	80µs

In normal mode.

The time for the output to reach within 0.1% of the final value after the output starts changing.

Pure resistive load. The limiter setting is at the full scale of the range. Source voltage or current is at the maximum value of the range.

LC Load

Current Source/Measurement/ Limiter Range	Normal Mode		Stable Mode	
	Max. C load	Max. L load	Max. C load	Max. L load
200 nA to 2 mA	0.01 µF	10 µH	100 µF	1 mH
20 mA	0.1 µF			
200 mA	1 µF			
2 A, 3 A	10 µF			

Output Noise (Typical)

20 mVp-p

For DC to 20 MHz, 2-V voltage source range, and 1-A current limiter range

Measurement Section

DC Voltage Measurement

Range	Measurement Range	Resolution	Accuracy ±(% of reading + V)	Temperature Coefficient ±(% of reading + V)/°C
200 mV	±210.000 mV	1 µV	0.015 + 200 µV (250 µV) {300 µV} [500 µV]	0.0025 + 30 µV (40 µV) { 45 µV} [60 µV]
2 V	±2.10000 V	10 µV	0.015 + 200 µV (400 µV) { 1 mV} [5 mV]	0.0025 + 30 µV (60 µV) {200 µV} [800 µV]
7 V	±7.1000 V	100 µV	0.015 + 2 mV (4 mV) { 10 mV} [50 mV]	0.0025 + 300 µV (600 µV) { 2 mV} [8 mV]
18 V	±18.0000 V	100 µV	0.015 + 2 mV (4 mV) { 10 mV} [50 mV]	0.0025 + 300 µV (600 µV) { 2 mV} [8 mV]

DC Current Measurement

Range	Measurement Range	Resolution	Shunt resistance	Accuracy ±(% of reading + A)	Temperature Coefficient ±(% of reading + A)/°C
200 nA	±210.000 nA	1 pA	1 M Ω	0.05 + 3 nA (3 nA) { 3 nA} [4 nA]	500 pA (500 pA) [500 pA] [600 pA]
2 µA	±2.10000 µA	10 pA	1 M Ω	0.025 + 3 nA (3 nA) { 4 nA} [6 nA]	500 pA (500 pA) [500 pA] [600 pA]
20 µA	±21.0000 µA	100 pA	100 k Ω	0.025 + 4 nA (6 nA) { 10 nA} [50 nA]	0.004 + 600 pA (900 pA) { 1.5 nA} [8 nA]
200 µA	±210.000 µA	1 nA	10 k Ω	0.02 + 40 nA (60 nA) { 100 nA} [500 nA]	0.003 + 6 nA (9 nA) { 15 nA} [80 nA]
2 mA	±2.10000 mA	10 nA	1 k Ω	0.02 + 400 nA (600 nA) { 1 µA} [5 µA]	0.003 + 60 nA (90 nA) { 150 nA} [800 nA]
20 mA	±21.0000 mA	100 nA	100 Ω	0.02 + 4 µA (6 µA) { 10 µA} [50 µA]	0.003 + 600 nA (900 nA) { 1.5 µA} [8 µA]
200 mA	±210.000 mA	1 µA	10 Ω	0.02 + 70 µA (100 µA) [150 µA] [500 µA]	0.003 + 10 µA (15 µA) { 20 µA} [80 µA]
1 A	±1.30000 A	10 µA	1 Ω	0.03 + 700 µA (1 mA) { 2 mA} [6 mA]	0.0045 + 100 µA (150 µA) [300 µA] [900 µA]
3 A	±3.20000 A	10 µA	1 Ω	0.05 + 1 mA (1.5 mA) { 2 mA} [6 mA]	0.0075 + 150 µA (200 µA) [300 µA] [900 µA]

One year accuracy for 23±5 °C.

Add the temperature coefficient for 5 to 18°C and 28 to 40 °C.

Values inside parentheses are for 0.1 PLC ? integration time < 1 PLC. Values inside braces are for 0.01 PLC ? integration time < 0.1 PLC.

Values inside brackets are for 0.001 PLC ? integration time < 0.01 PLC.

Functions

■ Source

Function: Voltage or current
 Mode: DC or pulse (pulse width: 50 μs to 3,600 s)
 Sweep mode: Linear, logarithmic, or program (up to 100,000 steps)
 Trigger source: External or internal timers 1 and 2 (period: 100 μs to 3600 s)
 Sweep start source: External or internal timers 1 and 2 (period: 100 μs to 3600 s)
 Source delay: 15 μs to 3600 s
 Response characteristics: Normal or stable

■ Measurement

Function: Voltage, current, auto, voltmeter mode, ammeter mode, or resistance meter mode
 Integration time: 0.001 to 25 PLC (Power Line Cycle)
 Trigger source: External or internal timers 1 and 2 (period: 100 μs to 3600 s)
 Measure delay: 0 μs to 3600 s
 Measurement data storage: Up to 100000 data points
 Average: Moving average (average count: 2 to 256)
 Voltage sense: Two-wire system or four-wire system
 Auto zero: Measure the internal zero reference every measurement and correct the measured value

NULL computation: Computes the difference with respect to the current measured value or user-defined value

User-defined computation: Computes user-defined equations in real-time
 Operators: +[addition], -[subtraction], *[multiplication], /[division], ^ [exponentiation], % [mod], | [logic OR], & [logic AND], ! [negation], < <= > >= != [comparison], = [substitution],

Functions: ABS() [absolute value], SQRT() [square root], LN(), LOG() [logarithm], SIN(), COS(), TAN() [trigonometric functions], ASIN(), ACOS(), ATAN() [inverse trigonometric functions], SINH(), COSH(), TANH() [hyperbolic functions], RAND() [random number generation], EDGE() [logic change extraction], TRUNC(), FLOOR() [rounding to an integer], ISINF() [infinity judgment], ISNAN [not-a-number judgment]
 Conditional statement: IF-THEN-ELSE

External I/O

■ BNC I/O

Connector type: BNC connector
 I/O level: TTL
 I/O logic format: Negative logic, falling edge
 Minimum pulse width: 10 μs

■ Digital I/O

Connector type: D-Sub 15-pin (765601 standard model)
 Half-pitch 50-pin (765602 digital I/O installed model)
 I/O level: TTL
 Minimum pulse width: 10 μs

Signal Name		Signal Name	
Channel 1 comparison result output	Comparison end	Digital output	DO12 *
	Comparison result low		DO13 *
	Comparison result IN		DO14 *
	Comparison result high		DO15 *
Channel 2 comparison result output	Comparison end	Digital input	DIO
	Comparison result low		DI1
	Comparison result IN		DI2 *
Interlock input			DI3 *
Digital output	DO0		DI4 *
	DO1		DI5 *
	DO2 *		DI6 *
	DO3 *		DI7 *
	DO4 *		DI8 *
	DO5 *		DI9 *
	DO6 *		DI10 *
	DO7 *		DI11 *
	DO8 *		DI12 *
	DO9 *		DI13 *
	DO10 *		DI14 *
	DO11 *		DI15 *

* DO2 to 15, DI2 to 15
 Available on the digital I/O installed model (765602)



D-Sub 15-pin (model 765601)



Half-pitch 50-pin (model 765602)

■ I/O for Synchronized Operation

Connector type: RJ-11 connector
 BNC connector (select the signal to be assigned to the input and output, separately)
 I/O level: TTL
 Minimum pulse width: 10 μs

I/O signal for synchronized operation

Pin No.	Sync Input Connector	Sync Output Connector
1	Output relay control input	Output relay control output
2	Sweep start input	Sweep start output
3	Trigger input	Trigger output
4	GND	GND
5	Auxiliary trigger input	Auxiliary trigger output
6	Zero source control input	Zero source control output



RJ-11 connector

Compatible cable: 758930

Communication Interface

■ GPIB

Electrical and mechanical specifications: Conforms to IEEE St'd 488-1987
 Functional specifications: SH1, AH1, T6, L4, SR1, RL1, PPO, DC1, DT1, C0
 Protocol: Conforms to IEEE St'd 488.2-1987
 Address: 0 to 30

■ RS232

Connector type: D-Sub 9-pin
 Electrical specifications: Conforms to EIA RS232
 Connection format: Point-to-point
 Transmission mode: Full-duplex
 Synchronization mode: Start-stop synchronization
 Baud rate: 9600, 14400, 19200, 38400, 57600, 115200 bps

■ USB interface

Number of ports: 1
 Connector type: Type B connector (receptacle)
 Electrical and mechanical specifications: Conforms to USB Rev. 2.0
 Protocol: Mass storage class, USB-TMC

■ Ethernet

Number of Ethernet ports: 1
 Connector type: RJ-45 connector
 Electrical and mechanical specifications: Conforms to IEEE 802.3
 Transmission system: 100BASE-TX/10BASE-T
 Data rate: 100 Mbps or 10 Mbps
 Protocol: VXI-11 server, HTTP server, FTP server, DHCP client, and command socket

General Specifications

Display: 256 × 64 dot VFD
 Rated supply voltage: 100 to 120 VAC or 200 to 240 VAC
 Rated supply frequency: 50/60 Hz
 Power consumption: Approx. 250 VA
 Warm-up time: At least 60 minutes
 Operating temperature and humidity range: 5 °C to 40 °C and 20% to 80%RH (no condensation)
 Storage temperature and humidity range: -15 °C to 60 °C and 20% to 80%RH (no condensation)
 Max. common-mode voltage: Between the case and each terminal ±250 Vpk
 Maximum allowable input voltage: Between high sense and low sense ±18 Vpk
 Between high output and low output ±18 Vpk
 Between high sense and high output ±0.5 Vpk
 Between low sense and low output ±0.5 Vpk
 Between each terminal of CH1 and each terminal of CH2 ±250 Vpk
 External dimensions: Approx. 213 (W) × 132 (H) × 450 (D) mm (excluding projections)
 Weight: Approx. 8 kg

■ External Dimensions

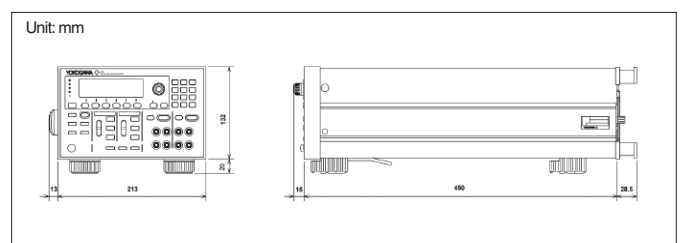

MODEL and SUFFIX Code

Model	Suffix Code	Notes
765601		GS820 Multi Channel Source Measure Unit Standard Model
765602		GS820 Multi Channel Source Measure Unit Digital I/O Installed Model
Power cord	-D	UL/CSA standard
	-F	VDE standard
	-R	AS standard
	-Q	BS standard
	-H	GB standard

Note:
The test certificate and calibration certificate can be requested only at the time of the order. Please don't forget to request them as they cannot be issued after the product has been delivered.

Standard Accessories

Power cord, rubber feet (4 pieces), measurement leads 758933 (2 sets), small alligator clip adapters 758922 (2 sets), user's manuals (1 set) External I/O connector

Rack Mount Kits

Model	Product	Specifications
751533-E3	Rack mount kit	For EIA single mount
751533-J3	Rack mount kit	For JIS single mount
751534-E3	Rack mount kit	For EIA dual mount
751534-J3	Rack mount kit	For JIS dual mount

Core 2 Duo is a registered trademark of Intel Corporation.
LabView is a registered trademark of National Instruments.
Ethernet is a registered trademark of XEROX Corporation.

Optional Accessories

Model	Product	Specifications
758933	Measurement lead	Safety terminal cable 1 m and 2 leads (red and black) in a set
758917	Measurement lead	Safety terminal cable 0.75 m and 2 leads (red and black) in a set
758919	Banana plug set	ø 4-mm plug/ø 4-mm socket adapter
758922	Small alligator clip adapter	Safety terminal-alligator clip adapter and 2 adapters (red and black) in a set
758929	Large alligator clip adapter	Safety terminal-to-alligator clip adapter and 2 adapters (red and black) in a set
758921	Fork terminal adapter	Safety terminal-to-fork terminal adapter and 2 adapters (red and black) in a set
758924	Conversion adapter	BNC-to-binding post adapter
366924	BNC cable	BNC-BNC cable 1 m
366925	BNC cable	BNC-BNC cable 2 m
758923	Safety terminal adapter	Spring clamp type pe 2 adapters (red and black) in a set
758931	Safety terminal adapter	Screw-in type pe 2 adapters (red and black) in a set
758960	Synchronization operation cable	RJ11 6-pin 1 m



758933 Measurement lead

2 pieces (red and black) in 1 set, length: 1.00 m
Used in combination with the 701959, 758921, 758922, or 758929.
Rating: 1000 V CAT III/19 A



758917 Measurement lead

2 pieces (red and black) in 1 set, length: 0.75 m
Used in combination with the 701959, 758921, 758922, or 758929.
Rating: 1000 V CAT III/32 A



758921 Fork terminal adapter

Safety terminal (banana female)-to-4 mm fork terminal adapter, 2 pieces (red and black) in 1 set
Rating: 1000 V CAT II
Connected to the 758933, 758917, or 701901.



758919 Banana plug set

ø 4-mm plug/ø 4-mm socket adapter
Rating: 30 VAC to 60 VDC 30 A



758922 Small alligator clip adapter

Safety terminal (banana female)-to-alligator clip adapter, 2 pieces (red and black) in 1 set
Rating: 300 V CAT II
Connected to the 758933, 758917, or 701901.



758929 Large alligator clip adapter

Safety terminal (banana female)-to-alligator clip adapter, 2 pieces (red and black) in 1 set
Rating: 1000 V CAT II
Connected to the 758933, 758917, or 701901.



758924 Conversion adapter

Safety terminal (banana female)-to-BNC (male) adapter
Connected to the 758933, 758917, or 701901.



366924/366925 BNC cable

366924: Length 1 m
366925: Length 2 m



758923 Safety terminal adapter set

Spring clamp type (banana male) 2 pieces in 1 set
Easy attachment/detachment of the cable.



758931 Safety terminal adapter set

Screw-in type (banana male)
2 pieces in 1 set
Comes with a B9317WD 1.5-mm hexagonal wrench for fixing the cable in place.

*1 Wire diameter of cables that can connect to the adapter
758923 Core wire diameter: 2.5 mm or less, covering diameter: 5.0 mm or less
758931 Core wire diameter: 1.8 mm or less, covering diameter: 3.9 mm or less

Related Products



GS610 Source Measure Unit

Wide-range source and measurement function
Source and measurement range: ±110 V and ±3.2 A



7651 Programmable DC Source

Highly accurate, highly stable, and low noise
Output range: ±30 V and ±120 mA

Note
 Due to the nature of the product, it is possible for the user to come in contact with metal parts and receive electric shock. Exercise caution when using the product.



YOKOGAWA ELECTRIC CORPORATION
Communication & Measurement Business Headquarters /Phone: (81)-422-52-6768, Fax: (81)-422-52-6624
E-mail: tm@cs.jp.yokogawa.com

YOKOGAWA CORPORATION OF AMERICA Phone: (1)-770-253-7000, Fax: (1)-770-251-6427
YOKOGAWA EUROPE B.V. Phone: (31)-33-4641858, Fax: (31)-33-4641859
YOKOGAWA ENGINEERING ASIA PTE. LTD. Phone: (65)-62419933, Fax: (65)-62412606

Subject to change without notice.
[Ed : 01/b] Copyright ©2007
Printed in Japan, 707(KP)